

BURLETES DE ESTANQUEIDAD

PILE WEATHERSTRIPPING



Seal Pile

Hilado de propileno fabricable en todas las medidas, según aplicación.

Spun of polypropylene, it can be manufactured in all sizes, according to its use.

Seal Rol

Centro con hilos de monofilamento. Mayor rigidez y sellado. Ideal para persianas arrollables.

The center has monofil yarns. More rigid and a tighter seal ideal for Roll-up blinds.

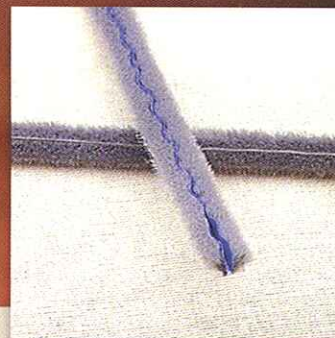

Seal Film

Barrera central formada por un film.

Gran estanqueidad. Central barrier made of a film. Waterproof.

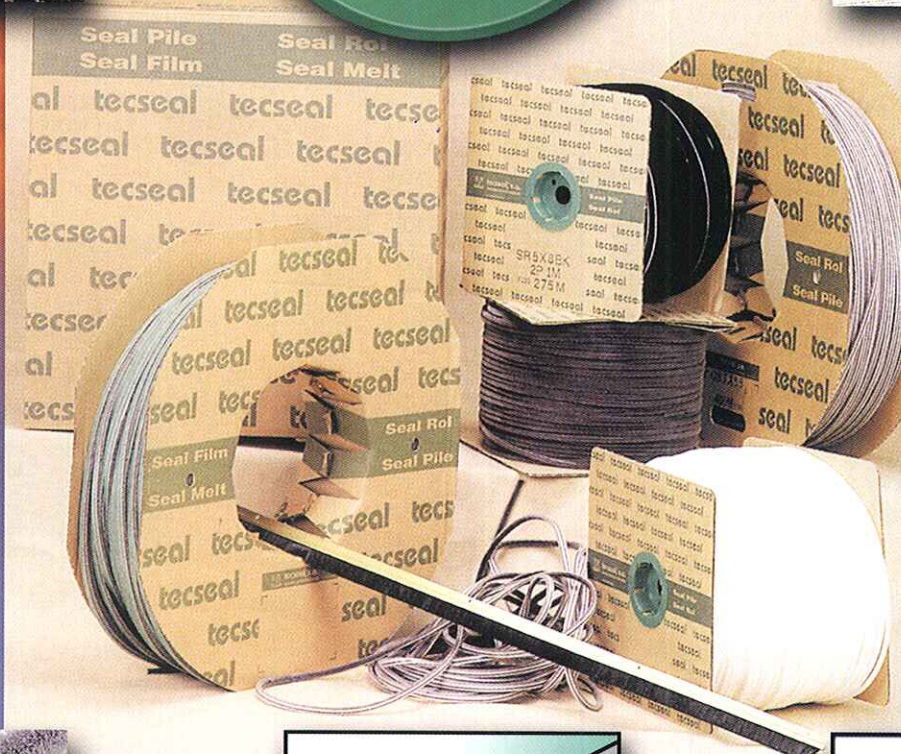

Seal Melt

Base autoadhesiva aplicable a todos los tipos.

Self adhesive backing can be applied to all types.

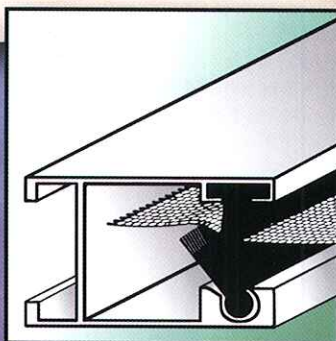

SR-2000

Para mosquitera evitando la salida del perfil.

No slipping-outs from profile.

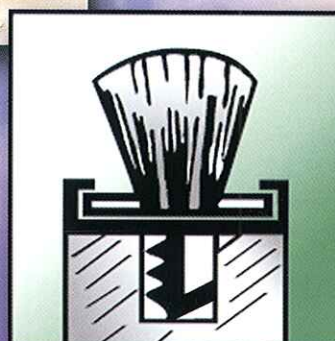

JM

Para puerta y ventana de madera.

For wooden windows and doors.

Aislese de las inclemencias del tiempo

ISOLATE ONESELF THE INCLEMENCY OF THE WEATHER



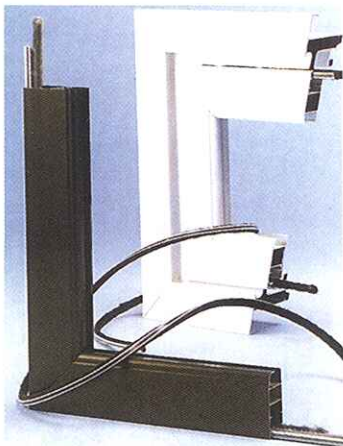

Seal Pile

Hilado de propileno fabricable en todas las medidas, según aplicación.
Spun of polypropylene, it can be manufactured in all sizes, according to its use.



Seal Rol

Centro con hilos de monofilamento. Mayor rigidez y sellado. Ideal para persianas enrollables.
The center has monofil yarns. More rigid and a tighter seal ideal for Roll-up blinds.



Seal Film

Barrera central formada por un film. Gran estanqueidad.
Central barrier made of a film. Waterproof.



Seal Melt

Base autoadhesiva aplicable a todos los tipos.
Self adhesive backing can be applied to all types.



SR- 2000

Para mosquitera evitando la salida del perfil.
No slipping-outs from profile.



JM

Para puerta y ventana de madera.
For wooden windows and doors.

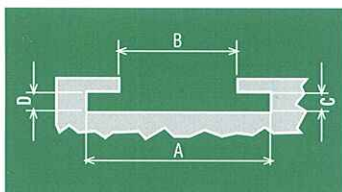

| MEDI- DAS | ANCHURA DE LAS LÁMINAS - PIE- | | | | | |
|--------------|-------------------------------|-----|-----|-----|-----|-----|
| | 4,8 | 5,8 | 6,7 | 8 | 9 | 11 |
| A | 5,3 | 6,6 | 7,7 | 9 | 10 | 12 |
| B | 3,2 | 4,0 | 4,5 | 4,8 | 5,7 | 6,7 |
| C | 2,5 | 2,5 | 2,5 | 2,5 | 2,5 | 2,5 |
| D | 1,3 | 1,3 | 1,3 | 1,3 | 1,3 | 1,3 |

| SP | 67 | 0525 | 4P | BK |
|-----------|----------------|----------------|---------------------|-----------------|
| Seal Pile | ancho width | alto height | densidad density | color colour |

SP-6,7x0525-4P BK

GR = Gris / Grey
BK = Negro / Black
BR = Marrón / Brown
WH = Blanco / White



Tecseal Laboratorio QC. / Laboratory QC.

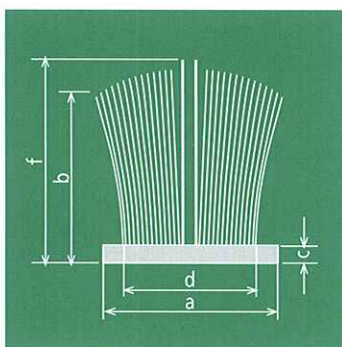

Tolerancias SF / Tolerances SF

a ANCHO BASE / BASE WIDTH

$$a = \begin{cases} +0,10 \text{ mm} & 4,8 \text{ mm} & \text{Max} = 4,90 \text{ mm} & \text{Min} = 4,60 \text{ mm} \\ -0,20 \text{ mm} & 6,9 \text{ mm} & \text{Max} = 7 \text{ mm} & \text{Min} = 6,70 \text{ mm} \end{cases}$$

b ALTURA PELO / PILE HEIGHT

+ 0,25 mm - 0,15 mm
Productos con altura superior a 6,50 mm
Products with superior height to 6,50 mm
+ 4% - 2,5%

c GROSOR BASE / BASE THICKNESS

Todos los productos / All the products
c = 0,80 mm ± 15 mm

d ANCHO PELO / PILE WIDTH

6,9 (4P) = 2,90 mm ± 0,30 mm
4,8 (4P) = 1,90 mm ± 0,15 mm

f ALTURA FILM / FILM HEIGHT

$$CF \quad f = \begin{cases} +0,20 \text{ mm} \\ -0,20 \text{ mm} \end{cases}$$

$$HF \quad f = \begin{cases} +0,50 \text{ mm} \\ -0,50 \text{ mm} \end{cases}$$

DENSIDAD / DENSITY

P.P.C.M. = 12 ± 0,5

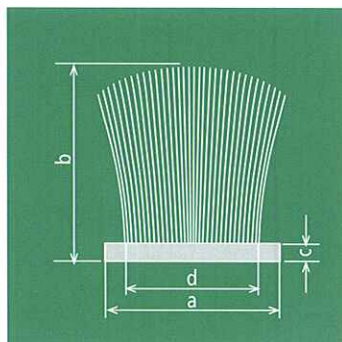

Tolerancias SP SR / Tolerances SP SR

a ANCHO BASE / BASE WIDTH

$$a = \begin{cases} +0,10 \text{ mm} & 4,8 \text{ mm} & \text{Max} = 4,90 \text{ mm} & \text{Min} = 4,60 \text{ mm} \\ +0,20 \text{ mm} & 6,9 \text{ mm} & \text{Max} = 7,00 \text{ mm} & \text{Min} = 6,70 \text{ mm} \end{cases}$$

b ALTURA PELO / PILE HEIGHT

+ 0,25 mm - 0,15 mm
Productos con altura superior a 6,50 mm
Products with superior height to 6,50 mm
+ 4% - 2,5%

c GROSOR BASE / BASE THICKNESS

Todos los productos / All the products
c = 0,80 mm ± 15 mm

d ANCHO PELO / PILE WIDTH

4,8 mm 2P y3P = 1,98 mm ± 0,12 mm
Max = 2,10 Min = 1,86 mm
6,9 mm 3P y4P = 2,90 mm ± 0,30 mm
Max = 3,20 Min = 2,60 mm
d = 1 línea pelo 1 mm ± 0,12 mm

DENSIDAD / DENSITY

P.P.C.M. = 12 ± 0,5



tecseal, s.a.

Pol. Ind. Can Parellada - C/ Neptuno, 12-16 - Tel.+34 93 731 26 24 - Fax +34 93 785 72 08
08228 **TERRASSA** (Barcelona) SPAIN
Web: www.tecseal.es - E-Mail: tecseal@tecseal.es - export@tecseal.es - admin@tecseal.es

TIMBER JOINT

JUNTA MADERA



www.tecseal.es

JM1

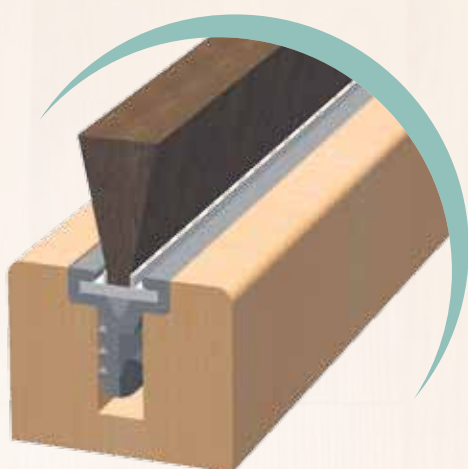

JM2

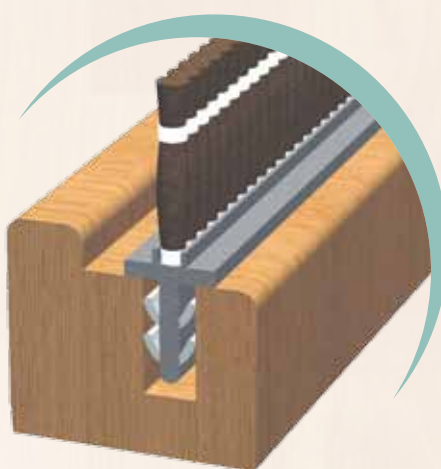

JM2B

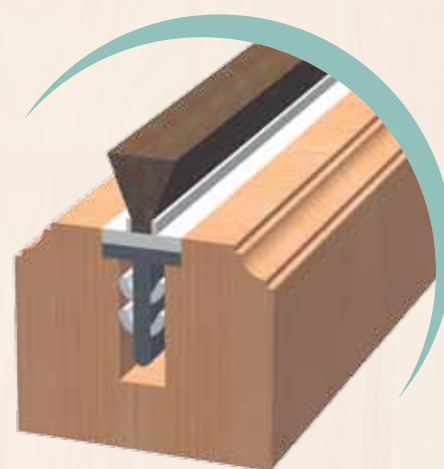

FLEXIBLE BASE NEW PACKAGING IN REELS

COMPOSITION

PVC and PPE carriers specially designed to fit in timber doors and windows by making a groove in the wooden surface.

COMPOSICIÓN: PVC y PPE juntas especialmente diseñadas para ser insertadas en puertas y ventanas de madera haciendo un canal en la superficie del perfil.

APPLICATIONS

Sliding windows and doors, door bottom seals, wardrobes, kitchen cupboards, swinging door, etc...

APLICACIONES: Puertas y ventanas correderas, armarios, bajo puertas, puertas de vaivén, armarios de cocina, etc...

COLOURS

Availability in WHITE, GREY, BEIGE, MEDIUM BROWN, DARK BROWN and BLACK. We produce our own yarn.

COLORES: Disposición en BLANCO, GRIS, BEIGE, MEDIO MARRÓN, MARRÓN OSCURO y NEGRO. Fabricamos nuestro propio hilo.



C/ Solsonès 62-64 - Pol. Ind. Pla de la Bruguera
08211 Castellar del Vallès- (Barcelona) España
Tel.: +34 93.731.26.24 - Fax: +34 93.785.72.08 - E-mail: tecseal@tecseal.es

www.tecseal.es

TIMBER JOINT

JUNTA MADERA



JM1

PACKAGING: 100 units per carton.

Standard length: 2.15 m, 2.60 m, 3.00 m or any desired measure.

BRUSH HEIGHT: from 4 mm to 30 mm.
 $b < 6,5 +0.25 -0.15$ mm
 $b > 6,5 +4\% -2.5\%$

AVAILABLE WITH: Fin and Monofilament pile.

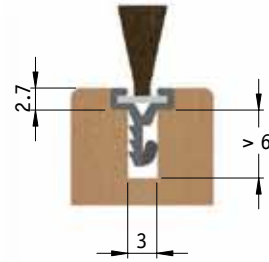
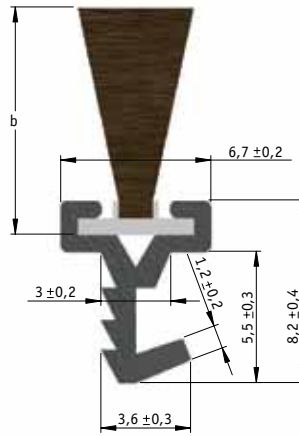

FIN

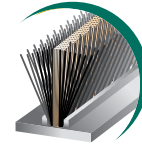

MONOFILAMENT PILE

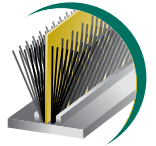

JM2

PACKAGING: 100 units per carton.

Standard length: 2.15 m, 2.60 m, 3.00 m or any desired measure.

BRUSH HEIGHT: from 8 mm to 30 mm.
 $b +4\% -2.5\%$

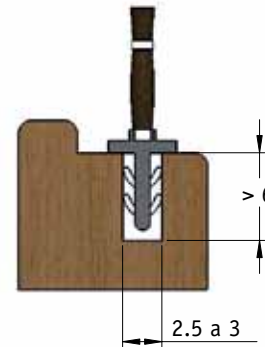
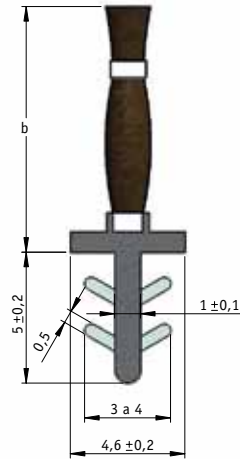

JM2B

PACKAGING: 100 units per carton.

Standard length: 2.15 m, 2.60 m, 3.00 m or any desired measure.

BRUSH HEIGHT: from 4 mm to 15 mm.
 $b < 6,5 +0.25 -0.15$ mm
 $b > 6,5 +4\% -2.5\%$

AVAILABLE WITH: Fin and Monofilament pile.

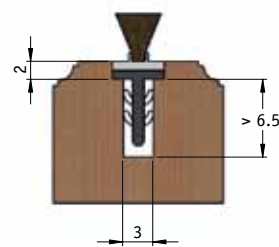
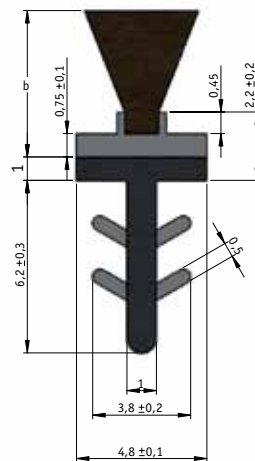

FIN

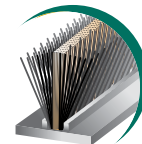

MONOFILAMENT PILE

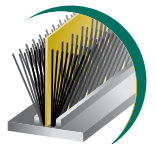

NEW PACKAGING FOR JM2 AND JM2B IN REELS

